

A) CONEXIÓN ESTRELLA; Velocidad Baja, más polos

B) CONEXIÓN DOBLE ESTRELLA; Velocidad alta, menos polos

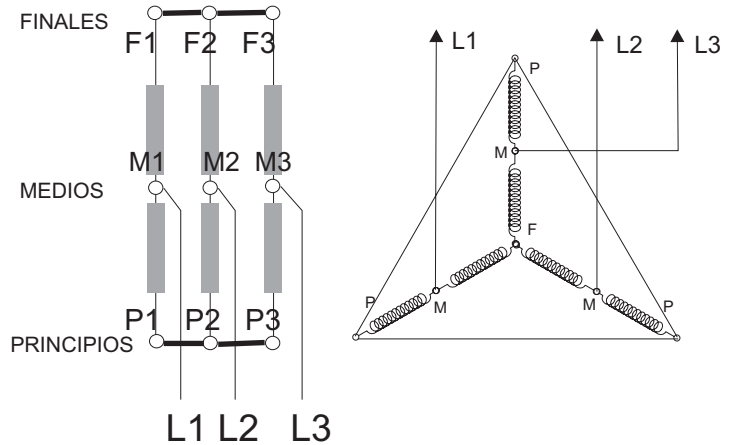
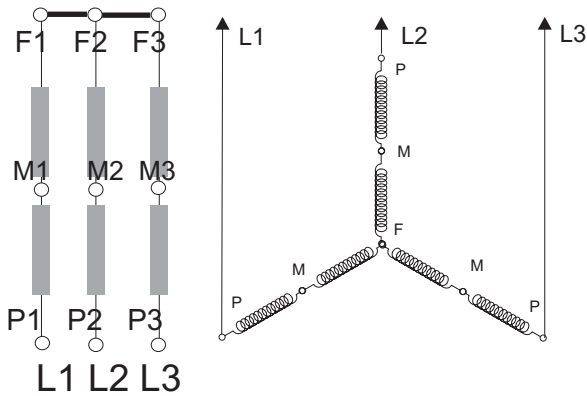

BOBINADO ÚNICO

CONEXIÓN: TRIÁNGULO

CONEXIÓN: DOBLE ESTRELLA

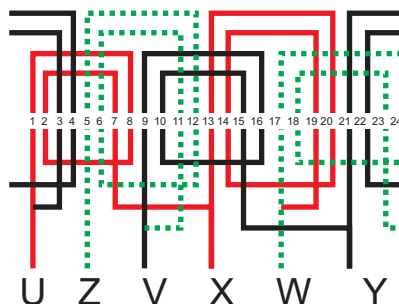
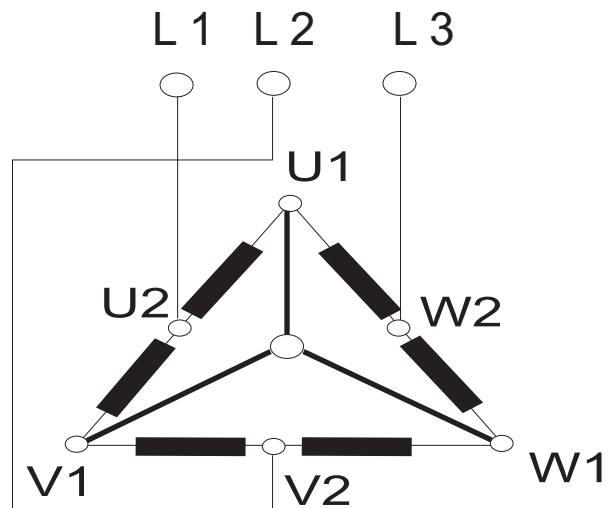
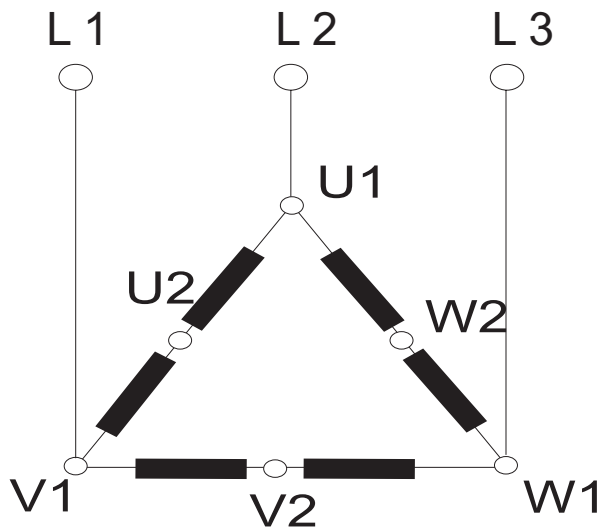
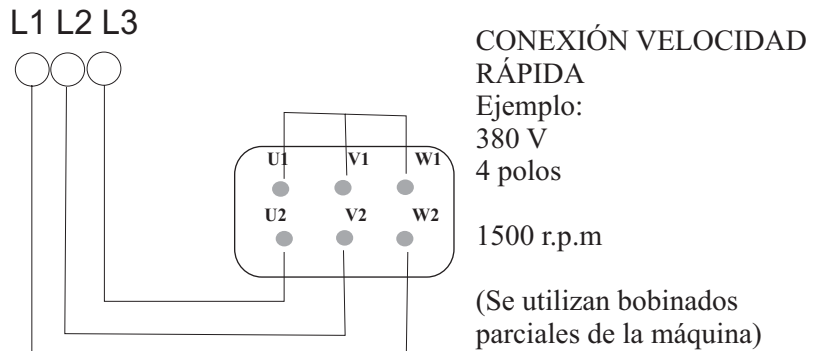
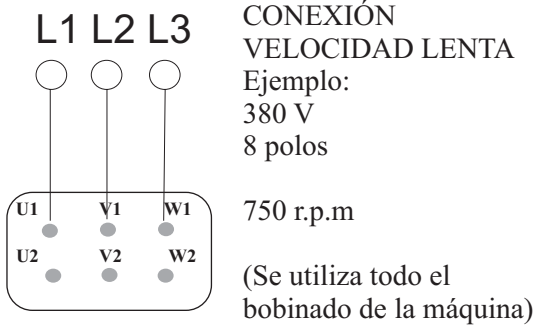

Z R U X S V Y T W

○ ○ ○ ○ ○ ○ ○ ○

■ ■ ■ ■ ■ ■ ■ ■

K = 24
2p = 2 y 2p = 4
q = 3
G = 2 x 3 = 6
Kpq = 2
U = 2
m = 4
Y120 = 8



Nombre: